

SBE-150W

(CB, CE, Export)

Commodity	LED CONVERTER (SMPS)
Model	SBE-150W
Description	150W 12V (Constant Voltage)

■ Features

- Constant Voltage design (C.V mode)
- AC Input Voltage 170 - 240V
- High efficiency up to 92%
- Protection: Over Current / Over Voltage / Over Temperature
- Suitable for LED lighting and moving sign applications
- Aluminium case
- Compliance to safety regulations for lighting
- 5 years warranty

■ Standards

Parameter	Condition	Remarks
Safety Standards	Design to meet the requirements as follows: - KC61347-1 , KC61347-2-13 , KC62384 - KS C 7655	
EMI/ EMC Standard	Design to meet the requirements as follows: - KC00015 , KC61547	

1. Electrical Specification

MODEL	SBE-150W		
DC output Voltage	12V DC	AC Input Voltage	170~240 Vac
DC output Current	12.5A	AC Input Current	1.1A
Line Regulation	±0.5%	Frequency	50/60Hz
Load Regulation	±1%	Power	165W
Efficient	92%	Power Factor	PF ≥ 0.6
Over Current Protection	Works at 130~150% of rating Auto recovery		
Over voltage Protection	Works at 120~140% of rating		
Over Temp. Protection	Activate latch mode at case temperature 95°C		
Withstanding Voltage	I/P-O/P : 3.65KVAC , I/P-FG : 1.5KVAC , O/P-FG : 0.5KVAC		
Working Temperature	-20~50°C , 80°C , at 100% load		
Dimension (W x D x H)	175 x 69 x 50.5 mm		
Weight	0.7kg		

2. Appearance



3. Block Diagram

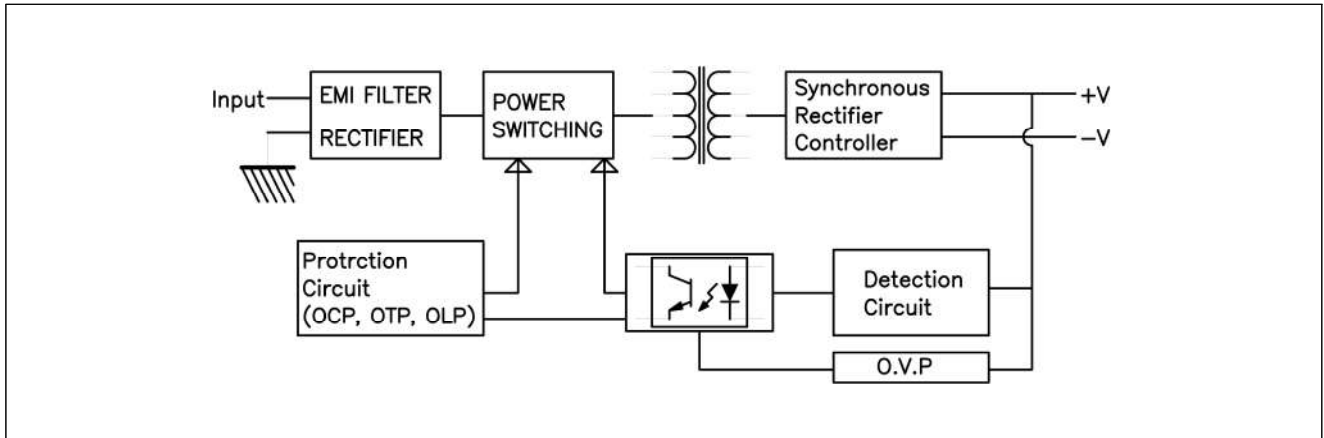

4. Mechanical Specification

